

# CR1500-400 COMBINERS

---

## *User's Manual*

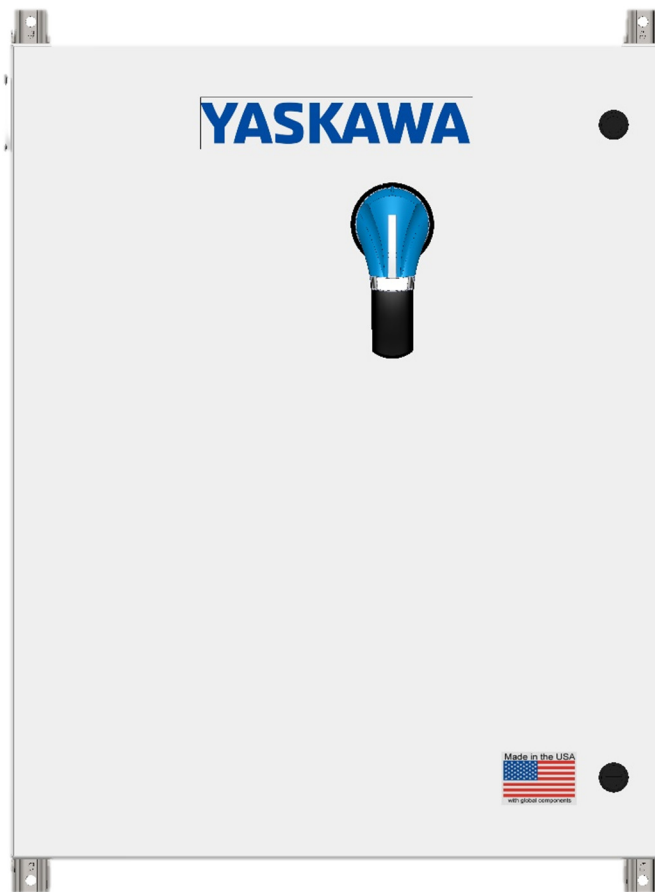

# CONTENTS

1. IMPORTANT SAFETY INSTRUCTIONS .....	3
2. PRODUCT OVERVIEW.....	4
3. RATINGS AND SPECIFICATIONS.....	6
4. INSTALLATION .....	7
4.1 Unpacking and Inspection .....	7
4.2 Mounting .....	7
4.3 Wiring.....	9
5. OPERATION.....	16
6. WARRANTY & RMA INSTRUCTIONS.....	17
7. APPENDICES.....	17

# FIGURES

2.1	Illustrated Example Usage of the DCR-1500-500 Re-Combiner in the SOLECTRIA PVS-500 Energy Storage System
2.2	The CR1500-400 DC Combiner
4.1	CR1500-400 Combiner front view (left) and side view (right), dimensions and mounting tab locations
4.2	CR1500-400 Combiner example mounting to struts
4.3	Bottom of the CR1500-400 Enclosure Showing Areas Available (shaded) for Conduit and Strain-Relief Fittings
4.4	PV Output Circuit Stud Plates (side view, left; top view, right)
4.5	Compression Lug Connections, Single and Dual Conductors
4.6	PV Source Circuit Equipment Ground Terminals
4.7	PV Output Circuit Equipment Ground Terminal
5.1	Switch Handle Positions for OFF (left) and ON (right)

# TABLES

3.1	CR1500-400 Combiner Ratings and Specifications
4.1	Fuseholder Specifications
4.2	Example 1500VDC Replacement PV Fuse
4.3	PV Output Circuit Terminal Specifications
4.4	Compression Lug Specifications

# 1. IMPORTANT SAFETY INSTRUCTIONS

## SAVE THESE INSTRUCTIONS

The SOLECTRIA Remote PV Combiner (CR1500-400) is compatible with and intended for the SOLECTRIA **PVS-500 Energy Storage System**. In addition, the CR1500-400 Combiner may also be used with any PV array and inverter for which it is suitably rated.

Before using the CR1500-400 Combiner, please read all instructions and caution markings in this manual and on the Combiner, as well as all other instructions and warnings for associated equipment.

This manual contains important instructions that must be followed during installation and operation of the CR1500-400 Combiner. To reduce the risk of electrical shock and to ensure the safe installation and operation of the Combiner, the following safety symbols are used to indicate dangerous conditions and important safety instructions.



**WARNING**  
Could Injure  
Personnel or  
Damage Equipment



Instructions  
for Qualified  
Personnel Only



Positive  
Connection  
Point Symbol



Negative  
Connection  
Point Symbol



Ground  
Connection  
Point Symbol



DC Electrical  
Connection  
Point Symbol



**WARNING:** Disconnect all PV modules before wiring. PV arrays produce dc voltage when exposed to light and could create a hazardous condition. Always verify the absence of voltage before performing work on the CR1500-400 Combiner.



**WARNING:** Connecting PV output circuits to the input of the Combiner and making the connection to the DC Re-Combiner, must only be done after receiving approval from the utility company and AHJ, and should only be performed by qualified persons.



**WARNING:** The CR1500-400 Combiner is intended for use with the SOLECTRIA **PVS-500 DC-Coupled Energy Storage System**; the CR1500-400 Combiner may also be used in with any PV array and inverter for which it is suitably rated.

## 2. PRODUCT OVERVIEW

The primary function of the CR1500-400 Combiner is to combine PV Source Circuits from a PV array in parallel, safely, and form a resulting PV Output Circuit for connection to downstream equipment. The CR1500-400 is intended for use in the SOLECTRIA **PVS-500 DC-Coupled Energy Storage System** and with the **XGI 1500-250** family of inverters. Refer to the illustration in Figure 2.1 showing the CR1500-400 Combiner's general usage within the SOLECTRIA **PVS-500 DC-Coupled Storage System**.

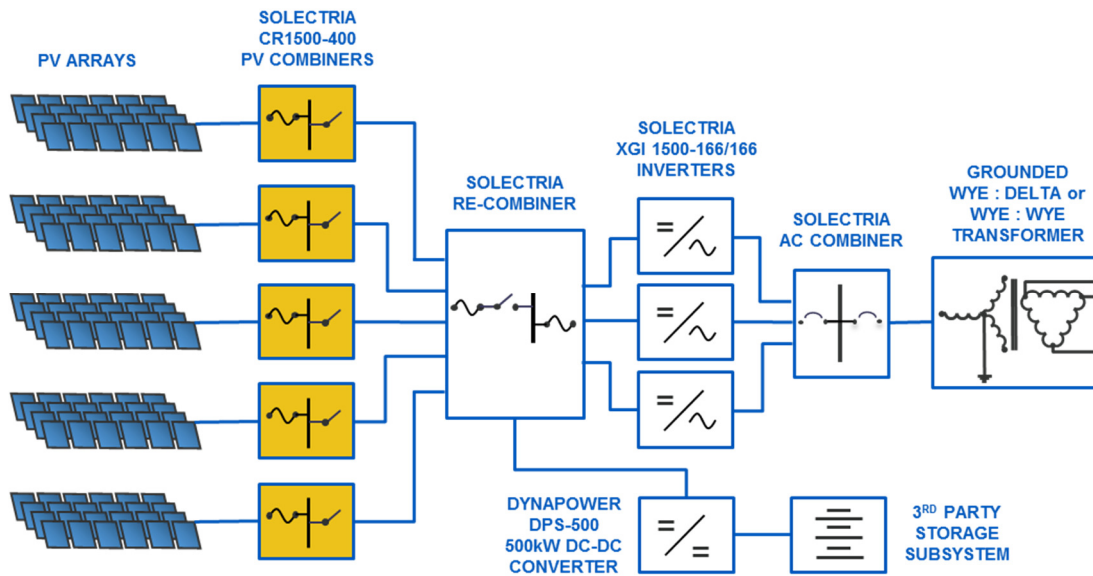

**Figure 2.1 – Illustrated Example Usage of the CR1500-400 Combiner in the SOLECTRIA PVS-500 Energy Storage System**

The CR1500-400 Combiners (see Fig 2.2) perform the following functions:

**(1) PV Source Circuit Connections:**

- Touch-safe fuseholders; models with terminals for 16, 20, 24, or 28 positive-polarity PV Source Circuit conductors
- Overcurrent protection provided by 20A, 25A, 30A or 32A fuses, factory installed for all positive-polarity PV Source Circuit conductors
- A 30-position bus for termination of the negative-polarity PV Source Circuit conductors
- Connection from all PV Source Circuit conductors to the internal DC bus

**(2) DC Disconnect Switch:**

- DC disconnect switch, 400A, two-pole, fully integrated and externally operable; separates the combined PV Source Circuits from the PV Output Circuit terminals and conductors

**(3) PV Output Circuit Connections:**

- Terminals accommodating single 750kcmil conductors or dual 500kcmil conductors per pole, for the field-installed PV Output Circuit conductors.
- Type II surge protection, factory installed.

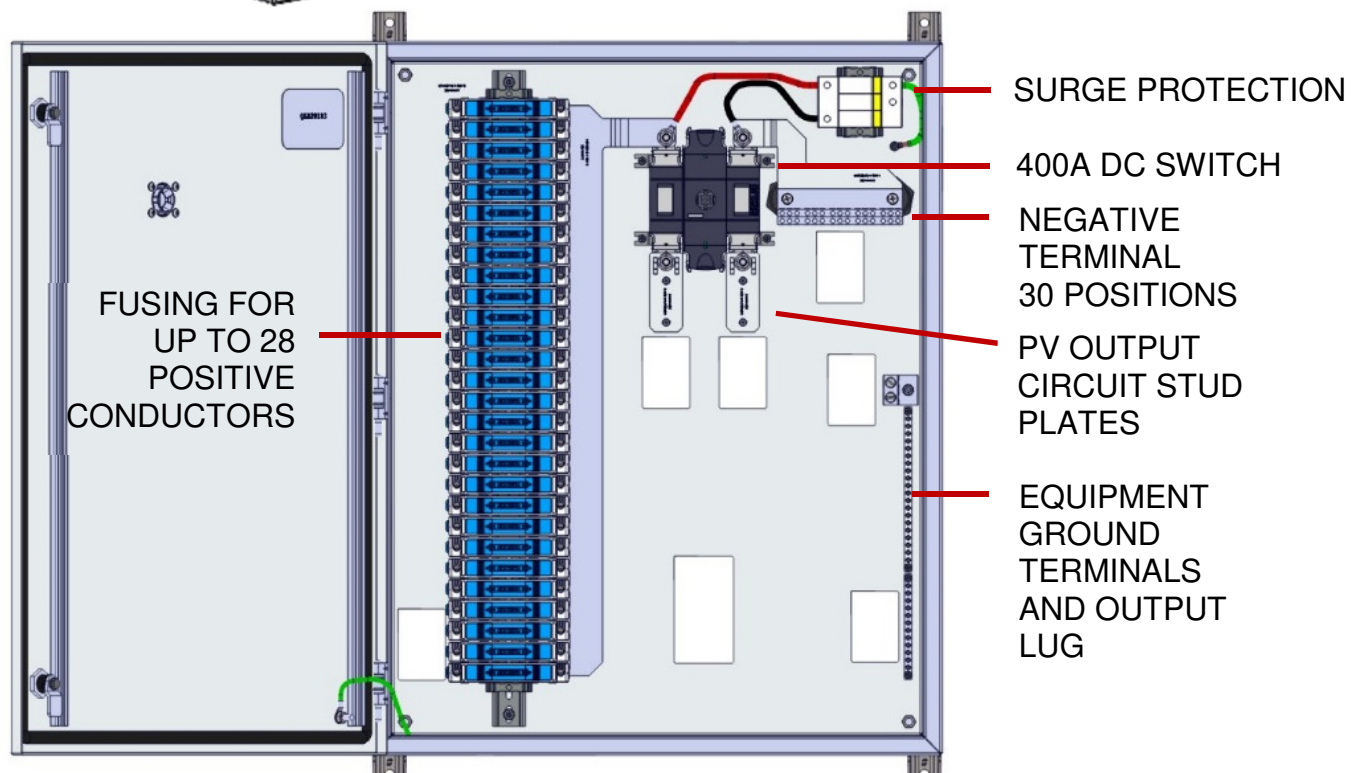
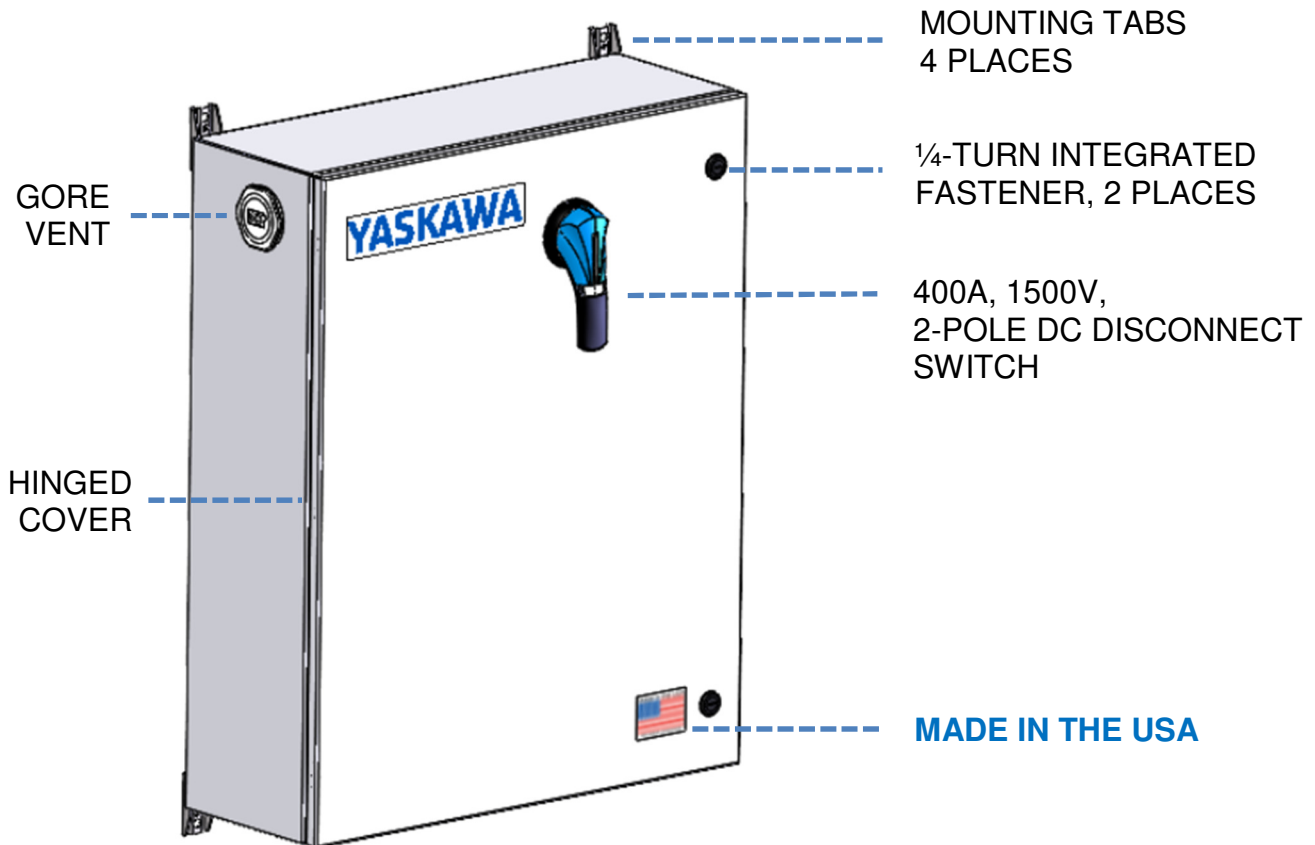

**Figure 2.2 - The CR1500-400 DC Combiner**

### 3. RATINGS AND SPECIFICATIONS

CR1500-400 SPECIFICATIONS	
<b>PV SOURCE CIRCUIT CONNECTIONS</b>	
Maximum Voltage	1500VDC
Fuseholder <ul style="list-style-type: none"> <li>• Wire Compatibility</li> <li>• Required Torque</li> <li>• Temperature Rating</li> <li>• Other</li> </ul>	<ul style="list-style-type: none"> <li>• 14 – 4AWG, PV-Rated, Copper Wire Only</li> <li>• 22 in-lb (2.5 N-m)</li> <li>• -40°C to +125°C</li> <li>• Touch-safe, lock-out/tag-out feature</li> </ul>
Fuse <ul style="list-style-type: none"> <li>• Rating</li> <li>• Type</li> </ul>	<ul style="list-style-type: none"> <li>• 20A, 25A, 30A or 32A, 1500VDC (factory installed)</li> <li>• Replace only with HP15M, or equivalent photovoltaic fuse</li> </ul>
Number of Fuse Positions	16, 20, 24 and 28 Positions
Fuse Configuration	Fusing for Positive Polarity Only
<b>DC DISCONNECT SWITCH</b>	
Configuration	2-pole, 400A, 1500VDC, externally operable
Maximum Continuous Current	320A
<b>PV OUTPUT CIRCUIT CONNECTIONS</b>	
Maximum Voltage	1500VDC
Maximum Wire Size Compatibility	Cu: 1 cond, 750 kcmil; 2 cond, 500 kcmil Al: 1 cond, 750 kcmil; 2 cond, 500 kcmil EGC Range: 14 AWG – 2/0 AWG
<b>MECHANICAL, ENVIRONMENTAL, SAFETY</b>	
Enclosure Dimensions (not including mounting tabs, see Fig. 4.1)	Height: 30.0 in (762mm) Width: 24.0 in (610mm) Depth: 8.00 in (203mm)
Enclosure Material & Rating	Polyester Powder-Coated Steel, Type 4
Weight	85 lbs
Ambient Temperature Range	-40°F to 140°F (-40°C to +60°C)
Surge Protection (Optional)	Type 2, +/-GND, Common/Differential Modes
Safety Certification & Listing / Certification Agency	Intertek, UL1741
Standard Warranty	5 Years standard

**Table 3.1 – CR1500-400 Combiner Specifications**

## 4. INSTALLATION

The steps for successful installation of the CR1500-400 Combiners are:

- (1) Unpacking and Inspection
- (2) Mounting
- (3) Conduit and Fittings
- (4) Wiring and Conductor Installation
- (5) Testing and Commissioning

### 4.1 Unpacking and Inspection

#### 4.1.1 Check for Damage

Yaskawa Solectria Solar thoroughly inspects and rigorously tests each CR1500-400 Combiner before it is shipped. Even though the Combiners are delivered in rugged packaging, damage could occur to the Combiners during shipment.

- ✓ Inspect the Combiner after removing it from its packaging. Take care not to set the Combiner on gravel or other surface that could scratch the paint.
- ✓ If damage is observed, take digital photos to document the damage and immediately report the damage to the shipping company.
- ✓ If the recipient has any question about the potential shipping damage, contact Yaskawa Solectria Solar (see Section 6 for contact information).
- ✓ If Yaskawa Solectria Solar determines that the Combiner must be returned, obtain an RMA number from Yaskawa Solectria Solar and instructions for returning the unit.

#### 4.1.2 Remove Packing Material Inside the Combiner

Remove and properly dispose of all cardboard, tape and other packing material that may be inside the Combiner enclosure.

### 4.2 Mounting

The Remote Combiner is designed to mount in any convenient location. Typically, the CR1500-400 Combiner will be mounted in the PV array, close to the input PV Source Circuits and some distance from the XGI 1500-250 series inverter or PVS-500 DC-Coupled Storage System equipment. The CR1500-400 is equipped with four integrated mounting tabs (see Fig. 4.1 and Fig 4.2) to facilitate attachment to a variety of surfaces. The CR1500-400 enclosure is rated Type 4 and will maintain this rating when the user follows appropriate installation methods.

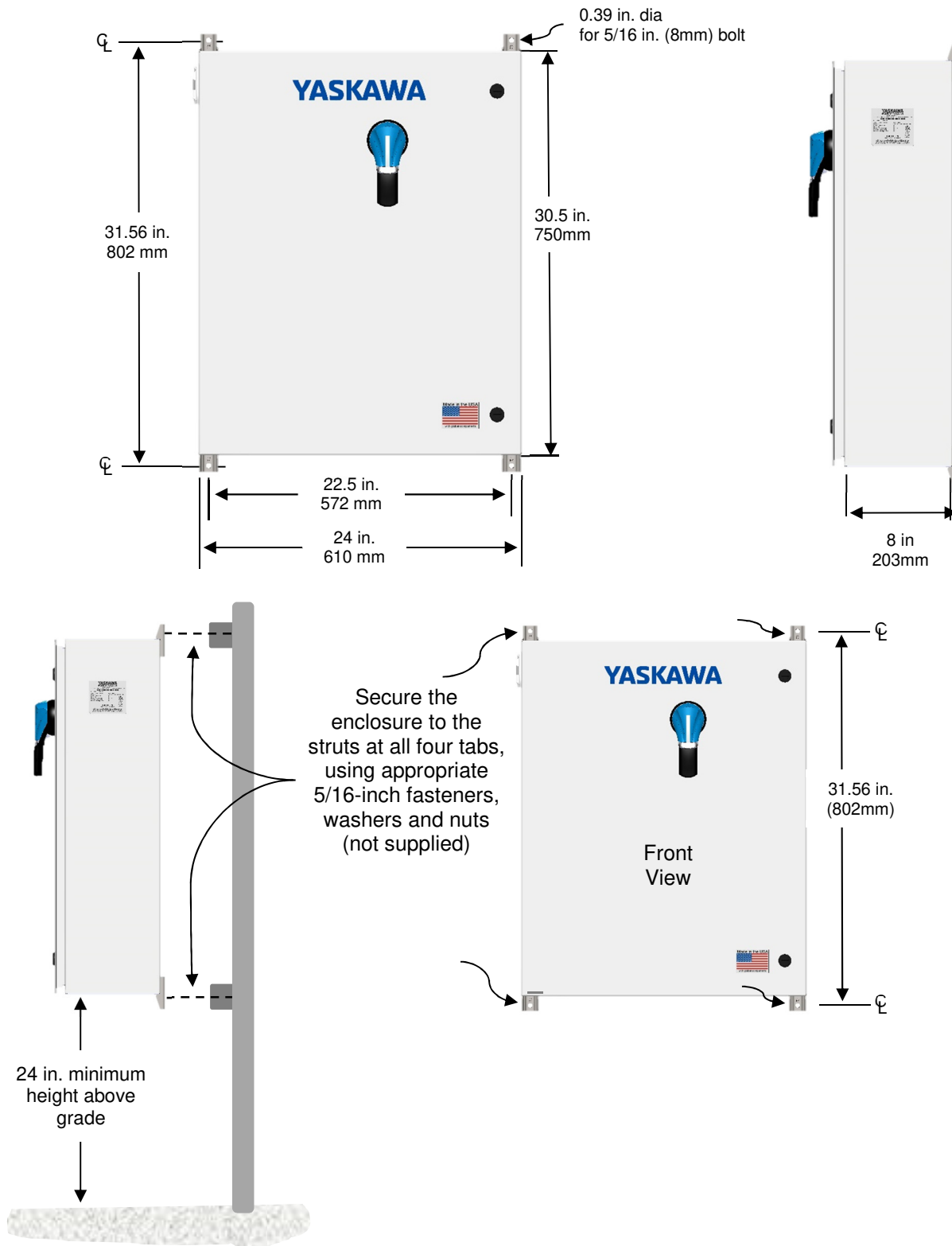

**Figure 4.1 - CR1500-400 Combiner front view (left) and side view (right), dimensions and mounting tab locations**



## 4.3 Wiring

Completing the installation of the CR1500-400 Combiner requires: (1) field wiring of the PV Source Circuits (up to 28) -- positive polarity conductors to the fuseholders, negative polarity conductors to the 30-position negative terminal block, and equipment ground wires to the equipment ground terminals, and (2) field wiring of conductors from the PV Output Circuit terminals and the equipment ground lug to the terminals in the XGI 1500-250 series inverter, or the DCR 1500-500 Re-Combiner (see the DCR 1500-500 Re-Combiner User's Manual for further details on connections to the Re-Combiner).

### STEP 1: Confirm That No Wiring is Connected to the Combiner

- ✓ This is the first step of the installation and no wiring should be present into or out of the CR1500-400 Combiner. No input PV Source Circuits conductors should be present, and no PV Output Circuit conductors should be present.
- ✓ If the XGI 1500-250 series inverter is in place, confirm that the DC disconnect switch on the inverter is on the OFF position. When used in the PVS-500 DC-Coupled Storage system, and the DC Re-Combiner is in place, confirm that the five PV Output Circuit DC disconnect switches are in their OFF position. All other equipment should be disconnected even though the wiring between the CR1500-400 Combiner and other equipment may not yet be in place. The window on the disconnect switch body will show the "O" (Off) switch status.
- ✓ Remove fuses from all of the touch-safe fuseholders in the CR1500-400. Store the fuses for later re-installation.

### STEP 2: Prepare the Enclosure for Conduits

- ✓ Conduit and strain reliefs can be located anywhere suitable on the bottom face of the Combiner as shown in Figure 4.3.
- ✓ Add the necessary holes for the conduit and fittings. The Combiner provides adequate space for up to six 9-conductor strain reliefs, readily accommodating up to 28 pairs of conductors from 28 input PV Source Circuits, the maximum allowable.
- ✓ Remove all metal shavings and debris from the inside of the Combiner.



Remove all metal shavings and debris from the inside of the CR1500-400 enclosure.

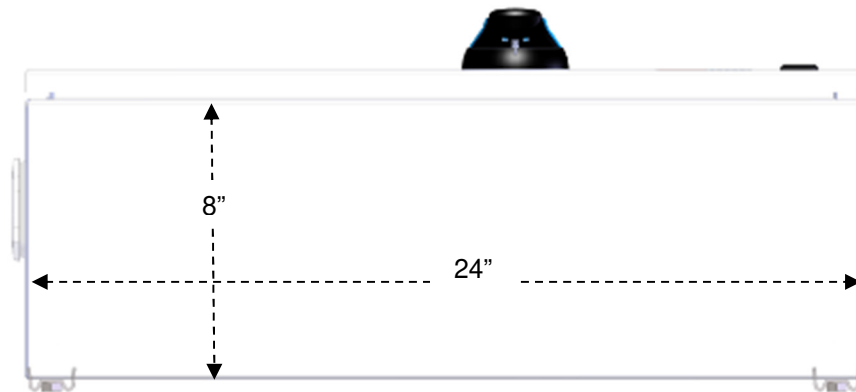

**Fig 4.3 Bottom of the CR1500-400 Enclosure**

### **Conduit Connections**



Conduits connected to an outdoor enclosure can introduce water vapor into the enclosure and lead to the formation of condensation inside. Failure to follow these guidelines can result in water intrusion into the unit through the conduit connections and may void the warranty.

Follow these instructions and best practices when securing conduits to the Re-Combiner.

1. Use UL514B certified water-tight conduit fittings and proper installation methods to provide a water-tight connection that will maintain the Type 4 rating of the enclosure.
2. Use an appropriately-rated sealant and seal the conduits fully to prevent the exchange of air between the conduit and the enclosure. Sealing the conduit will help prevent condensation in the enclosure.

### STEP 3: PV Source Circuit Connections



Do not attempt to make connections to the CR1500-400 Combiner if not qualified for electrical work.

See NEC Articles 310 and 690 for proper PV Source Circuit conductor sizing. The rating of the fuseholders and the range of compatible conductor sizes are shown in Table 3.2.

FUSEHOLDER SPECIFICATIONS	
<b>Wire Compatibility</b>	14 AWG – 6 AWG stranded 14 AWG – 10 AWG solid 90°C Copper Conductors Only
<b>Voltage Rating</b>	1500 VDC
<b>Ampere Range</b>	Up to 32A
<b>Torque Setting</b>	22 in-lb, #2 Phillips

**Table 4.1 - Fuseholder Specifications**

- ✓ Verify absence of voltage in PV Source Circuit conductors.
- ✓ Run the PV Source Circuit conductors into the Combiner either through conduit or strain-relief connectors.
- ✓ Connect the positive conductors to the touch-safe fuseholders, one conductor per fuseholder.
- ✓ Connect the negative conductors to the negative polarity terminals (not fused).
- ✓ Connect equipment ground conductors to the equipment ground terminals.
- ✓ Torque each PV Source Circuit conductor to 22 in-lb with a #2 Phillips screwdriver.

Only replace fuses in the CR1500-400 Combiner fuseholders with appropriately-rated 10x85mm, 1500Vdc photovoltaic fuses. An example fuse is identified in the table below.

Fuse Rating	Part Number
<b>20A</b>	Mersen HP15M20

**Table 4.2 – Example 1500VDC Replacement PV Fuse**

Negative PV Source Circuit conductors terminate on the 30-position terminal block, with the following specifications.

	<ul style="list-style-type: none"> <li>• 30 position</li> <li>• 4 – 14 AWG</li> <li>• Copper and Aluminum</li> <li>• 90C Rating</li> <li>• Torque to 20 in-lb</li> <li>• Flat-head screwdriver</li> </ul>
--	---

## STEP 4: PV Output Circuit Connections

The CR1500-400 Combiner provides stud plates just below the DC disconnect switch body, with 8mm (5/16 in.) studs for customer-supplied compression lugs for both positive and negative PV Output Circuit conductors. See Fig. 4.4. The terminals are rated for 90°C. Refer to NEC Articles 310 and 690 for proper sizing of conductors. One and two lugs are allowed. Basic specifications are in Table 4.3.

Wire Terminal Temperature Rating	Number of Terminals	Number of Wires per Terminal Allowed	Max Conductor Size Allowed (Copper or Aluminum Conductors)
90°C	1 per pole	1 – 2	(2) 500 kcmil or (1) 750 kcmil

**Table 4.3 – PV Output Circuit Terminal Specifications**

Compression lugs are NOT provided with the CR1500-400 Combiner. The lugs must conform to the specifications given in the table below:

Lug Type	Stud Spacing	Plating	Max. Tongue Width
Two-hole	1.75 in	Tin Plated	1.95 in

**Table 4.4 – Compression Lug Specifications**

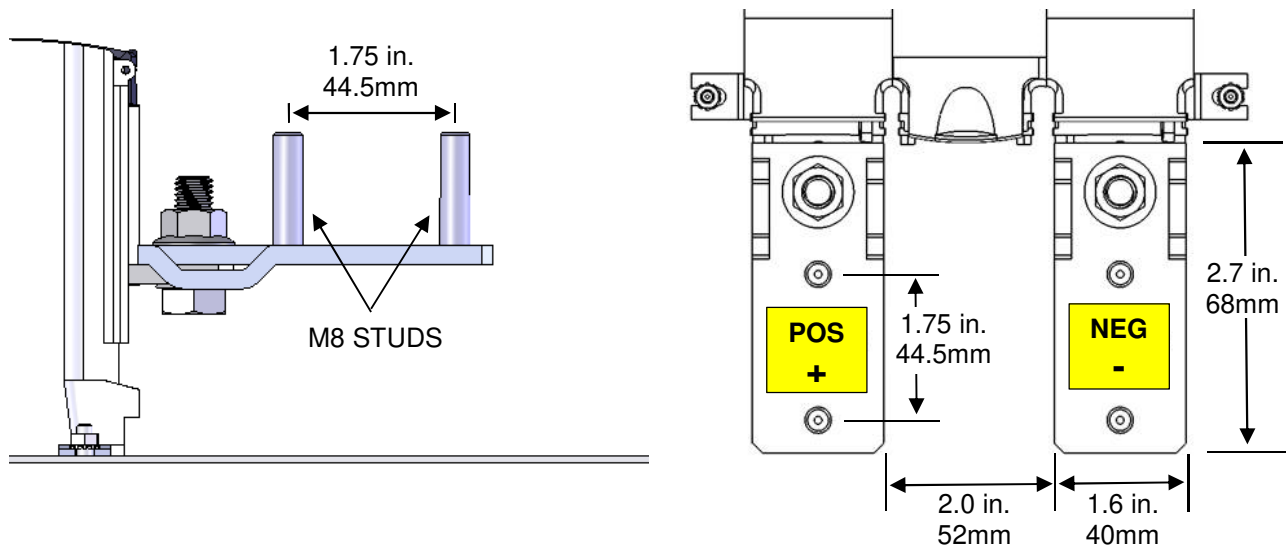

**Figure 4.4 – PV Output Circuit Stud Plates (side view, left; top view, right)**

For the hardware on the stud plate, use the following.

**Fasteners** 8mm flanged nut, SS  
Torque: 90 in-lb (10 Nm)

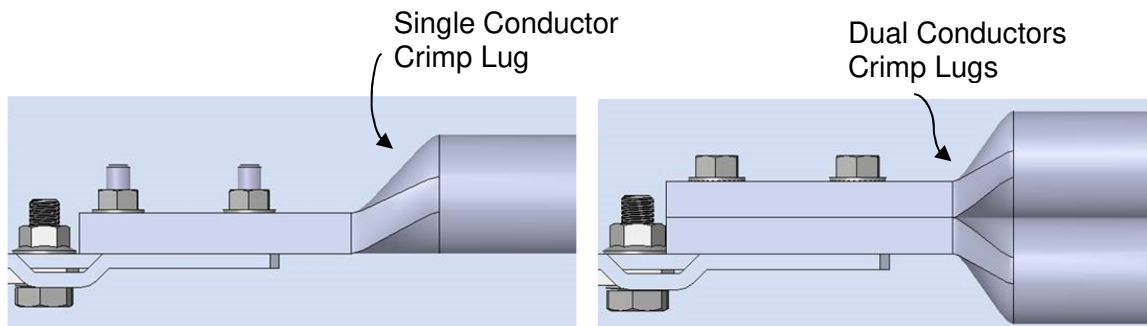

**Figure 4.5 – Compression Lug Connections, Single and Dual Conductors**

### Aluminum Conductors





Aluminum oxidizes quickly when exposed to the atmosphere. An oxidized layer is a poor conductor that could lead to thermal issues, production loss, or damage to the Re-Combiner.

When using aluminum conductors, follow these steps to prepare the conductors.

1. Prepare one wire at a time.
2. Remove the appropriate insulation from the wire.
3. Using a wire brush, remove the oxidized outer layer from the aluminum conductors.
4. Immediately apply a neutral dielectric grease, such as Ideal NOALOX® anti-oxidant compound, and connect the aluminum cable to the terminal.
5. If the connection is not made within 30 seconds of applying the compound, repeat this process, as an oxidized layer may have formed on the conductor.

## STEP 5: Equipment Ground Wire Connections

Terminals are provided in the Combiner for all Equipment Grounding Conductors (EGCs) associated with the PV Source Circuits. Torque each EGC for the PV Source Circuits per the specifications below.

	<ul style="list-style-type: none"><li>• 20 position</li><li>• 4 – 14 AWG</li><li>• Copper and Aluminum</li><li>• 90°C Rating</li><li>• Torque to 20 in-lb</li><li>• Flat-head screwdriver</li></ul>
	<ul style="list-style-type: none"><li>• 12 position</li><li>• 4 – 14 AWG</li><li>• Copper and Aluminum</li><li>• 90°C Rating</li><li>• Torque to 20 in-lb</li><li>• Flat-head screwdriver</li></ul>

**Fig. 4.6 - PV Source Circuit Equipment Ground Terminals**

The output Equipment Ground Conductor should be connected to the 2-position ground lug, with specs as in Figure 4.7, below.

	<ul style="list-style-type: none"><li>• 2 position</li><li>• (1) 14 – 2/0 AWG</li><li>• (2) 14 – 1/0 AWG</li><li>• Copper and Aluminum</li><li>• 90°C Rating</li><li>• Torque to 50 in-lb</li><li>• 3/16 Allen Hex</li></ul>
---	--

**Fig. 4.7 - PV Output Circuit Equipment Ground Terminal**

## Final Steps



Verify the proper polarity of each conductor. Polarity reversal can lead to dangerous conditions capable of harming personnel and damaging equipment.



Check the Combiner for tools and debris; ensure that the unit is clean and orderly.

- ✓ Return the fuses to the fuseholders, but do not close the fuse into the fuseholder. Closing the fuseholders will be accomplished during system commissioning and start-up.
- ✓ Verify that all connections meet the requirements of this User's Manual.
- ✓ Secure the CR1500-400 Combiner cover, ensuring that both ¼-turn fasteners are fully secured.
- ✓ Consult the startup and commissioning procedures for the inverter (XGI 1500-250/250-600, XGI 1500-225-600, XGI 1500-200/200-480, or XGI 1500-175-480) or PVS-500 DC-Coupled Energy Storage system before energizing.

## 5. OPERATION



Do not operate the disconnect handle switch with the Combiner Box door open.

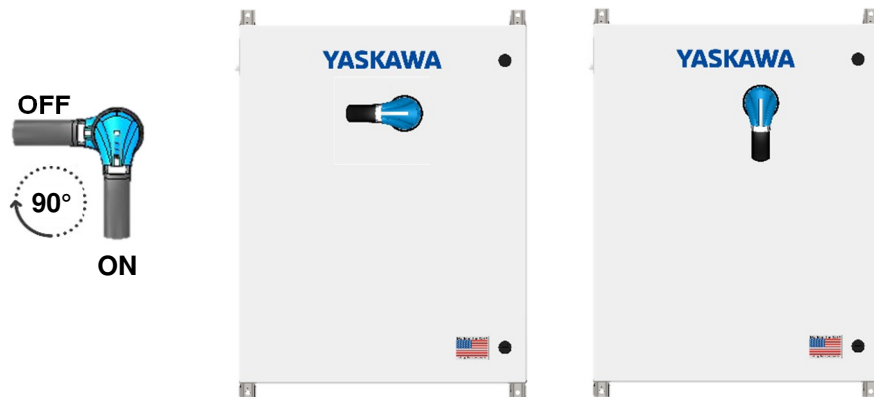

Figure 5.1 – Switch Handle Positions for OFF (left) and ON (right)

The CR1500-400 Combiner contains a user-operable disconnect switch. When this disconnect switch handle is in the OFF position, the circuit is open between the ungrounded PV Source Circuit conductors and the ungrounded PV Output Circuit conductors. The disconnect handle can be locked in the OFF position with user-supplied safety locks. The plastic tab on the face of the disconnect handle can be lifted to reveal the locking provisions.

When the disconnect switch is in the ON position, the PV Source Circuit is closed between the ungrounded PV Source Circuit conductors and the ungrounded PV Output Circuit conductors.

The disconnect switch is rated for 400A, fully load-break rated and can be safely operated under normal operating conditions when installation is per this User's Manual and all warnings and ratings are observed.

- ⇒ All Disconnect Switches must be OFF before working on the Combiner.
- ⇒ See also, as relevant, the User's Manual for the ***XGI 1500-250 Series Inverters*** or the User's Manual for the ***PVS-500 Energy Storage System***.



## 6. WARRANTY & RMA INSTRUCTIONS

For warranty information, please visit: <http://solectria.com/support/documentation/warranty-information/grid-tied-inverter-warranty-letter/>

## 7. APPENDICES

### **Appendix A – Contact Information**

Yaskawa Solectria Solar  
360 Merrimack Street  
Building 9, Suite 221  
Lawrence, MA 01843 USA  
Tel: 978.683.9700  
Fax: 978.683.9702

Sales/General Info: [inverters@solectria.com](mailto:inverters@solectria.com)  
Customer Support: 978-683-9700 x2  
Website: [www.solectria.com](http://www.solectria.com)

## **Appendix B - UL1741 Authorization to Mark**